

≡COFLOW

EcoFlow Glacier
Portable Fridge
User Manual V1.0

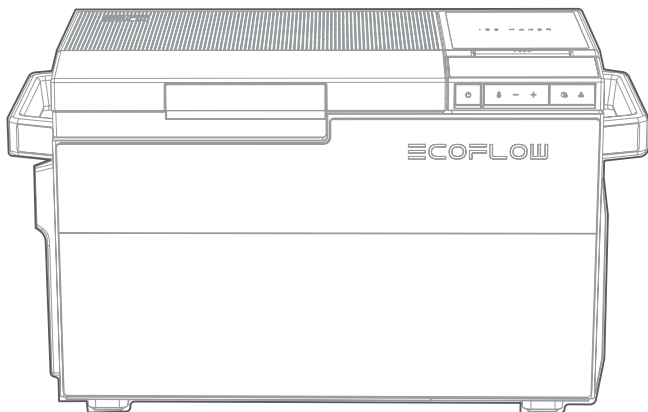

Disclaimer

Read this user manual carefully before using the product to ensure that you completely understand the product and can correctly use it. After reading this user manual, keep it properly for future reference. Improper use of this product may cause serious injury to yourself or others, or cause product damage and property loss. Once you use this product, it is deemed that you understand, approve and accept all the terms and content in this document. EcoFlow is not liable for any loss caused by the user's failure to use this product in compliance with this user manual.

In compliance with laws and regulations, EcoFlow reserves the right to final interpretation of this document and all documents related to this product. This document is subject to changes (updates, revisions, or termination) without prior notice. Please visit EcoFlow's official website to obtain the latest product information.

Contents

Technical Specifications	1
Safety Instructions	2
EcoFlow App	5
Installation Instructions	6
Select an ideal installation place	6
Set the refrigerator steady	6
Clean and install accessories	6
Connect to the power supply	8
How to Use the Product	11
Refrigerator parts and food storage suggestions	11
LCD indicators	13
Power-on/off	14
Temperature settings and functional operations	14
Precautions	18
Care and maintenance	18
How to Remove and Clean Internal Parts	18
Drainage	19
Defrosting	20
Error display and Troubleshooting	20
Package contents	21

Technical Specifications

Basic Information	
Model	EFBX100
Climate class	SN/N/ST/T
Type of protection against electric shock	Class II
Operational volume	Single zone: 38 L Dual zone: 36 L
Dimensions (L × W × H)	776 mm × 385 mm × 445 mm (wheels and telescopic handle not included) (30.6 in × 15.2 in × 17.5 in) 852.4 mm × 385 mm × 445 mm (wheels and telescopic handle included) (33.6 in × 15.2 in × 17.5 in)
IP rating	IPX4
Working mode	Common mode (quick freezing mode) and Eco mode
Quick freezing mode (30°C to 0°C)	15 minutes
Compressor power rating	120 W
Power consumption	Fridge: 0.18 kWh/24 h (ambient temperature at 25°C (77°F) and set temperature at 4°C (39°F), Eco mode) Freezer: 0.38 kWh/24 h (ambient temperature at 25°C (77°F) and set temperature at -18°C (0°F), Eco mode)
Refrigerant type and amount	R600a, 32 g
Foaming agent	Cyclopentane
Average noise (Noise Pressure Level)	Ice making: <52 dB(A); Temperature Maintaining: <42 dB(A)
Wi-Fi	This product supports 2.4G Wi-Fi only.
Bluetooth	Supported
Net weight	23.3 kg (51.4 lbs)
Input parameters	
AC input voltage/frequency	100-240 V, 50/60 Hz
AC input power	180 W
Battery pack power	100 W (USB-C)
Solar charging input	240 W (11-60 V, 13 A MAX)
Car charging input	96/192W (12/24V, 8A Max)
Operation environment	
Operating temperature	-20°C - +50°C (-4°F - +122°F) (When powered by 12V car charger only: -20 - +43°C)
Storage temperature	-20°C - +60°C (-4°F - 140°F)

Safety Instructions

This user manual contains a lot of important safety information. Please be sure to read and follow all safety information.

Explanation of symbols

 This is a safety warning symbol. Such safety information alerts you to hazards that can be lethal to you and others, and that can cause damages to the product. All safety information is preceded by safety warning symbols and hazard words, including: DANGER, WARNING, and CAUTION.

 **DANGER!**
Indicates a hazardous situation that, if not avoided, will result in death or serious injury.

 **WARNING!**
Indicates a hazardous situation that, if not avoided, could result in death or serious injury.

 **CAUTION!**
Indicates a hazardous situation that, if not avoided, could result in minor or moderate injury.

 **NOTICE!**
Indicates a situation that, if not avoided, can result in property damage.



Warning: Risk of fire / flammable materials.



United Nations Global Harmonized System (GHS) symbol

 **DANGER!**

Electrocution hazards

- If this cooling device's power cable is damaged, it must be replaced by the manufacturer, customer service or a qualified person in order to prevent safety hazards.
- Do not touch exposed cables with your bare hands. This applies especially when operating the device from the AC mains.

- Before starting the device, ensure that the power supply line and the plug are dry. Ensure that the power cable and the plug are securely connected.



WARNING!

Electrocution hazards

- Do not operate the cooling device if it is visibly damaged. Immediately stop the device and switch off all power supplies.
- If this cooling device's power cable is damaged, it must be replaced to prevent safety hazards.
- This cooling device may only be repaired by qualified personnel. Improper repairs can lead to considerable hazards.

Fire hazards

- When installing or positioning the device, ensure the supply cord is not trapped or damaged.
- Do not locate multiple portable socket-outlets or portable power supplies at the rear of the device.
- Keep the ventilation openings on the device housing or in installations free of obstructions.
- Do not use any mechanical objects or other means to speed up the defrosting process, unless they have been recommended by the manufacturer for this purpose.
- Do not use mechanical devices or other means to accelerate the defrosting process, other than those recommended by the manufacturer.
- Do not use electrical appliances inside the food storage compartments of the device, unless they are of the type recommended by the manufacturer.
- Do not place the cooling device near naked flames or other heat sources (heaters, direct sunlight, gas ovens etc.).
- Do not damage the refrigerant circuit.

Health hazards

- This device can be used by children aged from 8 years and above and persons with reduced physical, sensory or mental capabilities or lack of experience and knowledge if they have been given supervision or instruction concerning use of the device in a safe way and understand the hazards involved.
- Children should not play with the device.
- Cleaning and user maintenance should not be made by children without supervision.
- Children aged from 3 to 8 years are allowed to load and unload cooling devices.
- Fill with potable water only.
- Risk of child entrapment. Before you throw away your old refrigerator or freezer:
 - Take off the doors.
 - Leave the shelves in place so that children may not easily climb inside.
- Please keep children away from the packaging as folded cartons or plastic film may cause suffocation.

Explosion hazards

- Do not store any explosive substances such as spray cans with a flammable propellant in the cooling device.



CAUTION!

Electrocution hazards

- To avoid a hazard due to instability of the appliance, it must be fixed in accordance with the instructions.
- Before starting the cooling device, ensure that the power supply line and the plug are dry.
- Disconnect the cooling device from the power supply
 - before each cleaning and maintenance
 - after every use

Health hazards

To avoid contamination of food, please respect the following instructions:

- Please check if the cooling capacity of the device is suitable for storing the food or medicine you wish to cool.
- Food should only be stored in its original packaging or in suitable containers.
- Opening the cooling device for long periods can significantly increase the temperature in the compartments of the device.
- Regularly clean surfaces that can come in contact with food and accessible drainage systems.
- If the device is left empty for long periods:
 - Switch off the device.
 - Defrost the device.
 - Clean and dry the device.
 - Leave the door open to prevent mold developing within the device.



NOTICE!

- When handling the refrigerator, hold the handles on both sides of the refrigerator or use detachable telescopic handle (optional) and detachable wheels (optional).
- Check that the voltage specification on the data plate corresponds to that of the energy supply.
- Only connect the cooling device as follows:
 - With a car charging cable providing a DC power supply in the vehicle
 - With the AC adaptor +cable providing an AC power supply
- Never pull the plug out of the socket by the cable.
- Please wait for more than 10 seconds when unplugging and reconnecting the power plug. Otherwise, the refrigerator may malfunction.
- Do not place heavy objects or objects harmful to the refrigerator (containers containing liquids) on the refrigerator, so as to avoid injury, fire, or electric shock due to falling objects when opening and closing the refrigerator doors.
- Never put your hands or metal rods into the cold air outlet, lid, bottom of the refrigerator, and the heat shields (vents) on the sides.
- Never put your hands into the ice-making compartment.

- The cooling device is not suitable for transporting caustic materials or materials containing solvents.
- The insulation of the cooling device contains flammable cyclopentane and requires special disposal procedures. Deliver the cooling device at the end of its life-cycle to an appropriate recycling center.
- **Overheating risks!**
Ensure at all times that there is a minimum of 2 in (50 mm) ventilation on all four sides of the cooling device. Keep ventilation openings, in the appliance enclosure or in the built-in structure, clear of obstructions. Do not place the cooling device in closed compartments or areas with zero or minimal air flow.
- Ensure that the ventilation openings are not covered.
- Do not fill the inner container with ice or fluids.
- Never immerse the cooling device in water.
- Protect the cooling device and cables against heat and moisture.
- The device shall not be exposed to rain.

Intended use

The refrigeration device is intended to be used in household, outdoor, vehicle, boat and similar applications such as:

- Staff kitchens in stores, offices and other work areas
- Farmhouses
- By clients in hotels, motels and other residential type environments
- Bed and breakfast type environments
- Catering and similar non-retail applications
- Camping use:
 - suitable for camping use;
 - the appliance shall not be exposed to rain (not applicable to appliances with a degree of protection against harmful ingress of water of at least IPX4).

EcoFlow App



Control, monitor and customize your EcoFlow devices from afar with the EcoFlow App. Download at:
<https://download.ecoflow.com/app>

Privacy Policy

By using EcoFlow Products, Applications and Services, you consent to the EcoFlow Term of Use and Privacy Policy, which you can access via the “About” section of the “User” page on the EcoFlow App or on the official EcoFlow website at <https://www.ecoflow.com/policy/terms-of-use> and <https://www.ecoflow.com/policy/privacy-policy>



This product ONLY SUPPORTS 2.4GHZ WIFI.

Installation Instructions

- ⚠ WARNING!** Ensure that the refrigerator is disconnected from the mains before installing and adjusting accessories.

1. Select an ideal installation place

Keep an appropriate distance between the refrigerator and surrounding objects. Ensure at all times that there is a minimum of **2 in (50 mm)** ventilation gap on all four sides of the refrigerator. If the gap with the surrounding is too small, it will inhibit the refrigerator from dissipating heat energy, resulting in a decrease in refrigeration capacity and an increase in power consumption.

Install the refrigerator in a dry and well-ventilated place. Try to avoid direct sunlight on the refrigerator.

- If the ambient temperature is too high, the refrigeration capacity of the refrigerator may decrease and the power consumption may increase.
- If the refrigerator is installed in a place with excessive gas or smoke, the surface of the refrigerator will have a color change.

2. Set the refrigerator steady

- When installing the refrigerator on the carpet or floor, please put a solid pad underneath to prevent discoloration. Please do not directly use the bottom tray that is placed under the refrigerator upon factory delivery.
- Unstable installation will cause vibration and noise.
- The anti-tilt angle of this product is 30°. When the tilt angle is greater than 30°, the anti-fall protection will be activated.

3. Clean and install accessories

- Clean any dust accumulated during transportation of the refrigerator.
- Install accessories at the appropriate positions in the refrigerator, such as telescopic handle (optional), wheels (optional), EFBX100-EB battery pack (optional), basket, temperature zone divider.

Installing the wheels (optional)

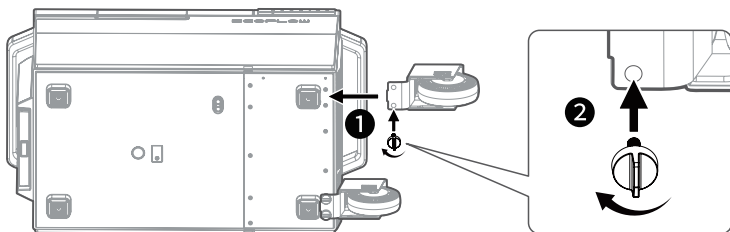

Installing Detachable Telescopic Handle (optional)

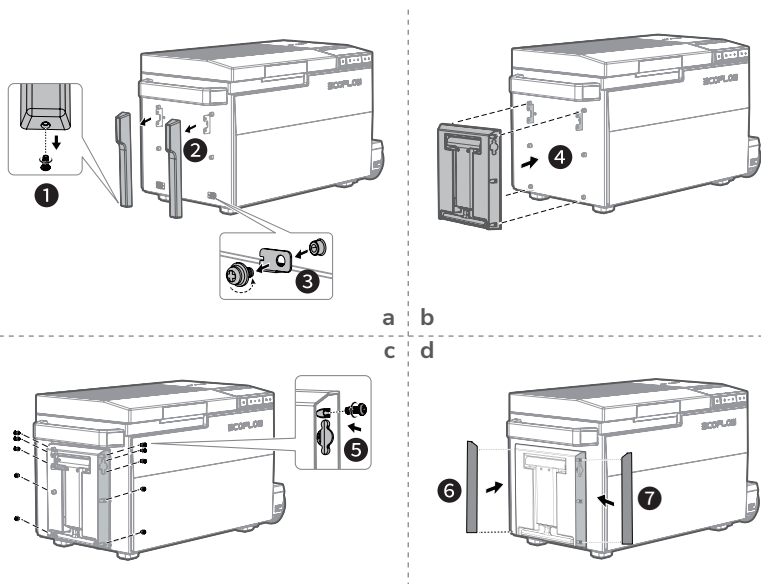

How to remove the handles

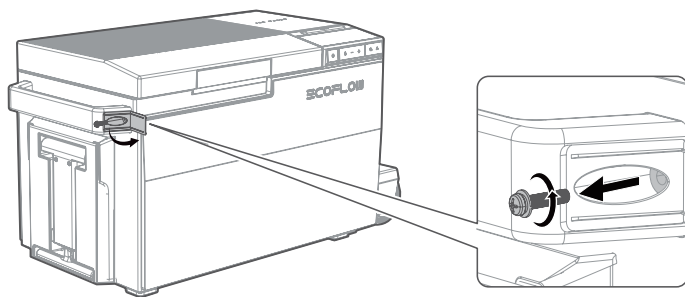

4. Connect to the power supply.

This product supports AC mains, car charging (12V/24V), and solar charging (EFBX100-EB battery pack (optional) must be connected).

AC mains

⚠ WARNING! Please use a dedicated power outlet, which should not be shared with other electrical appliances.

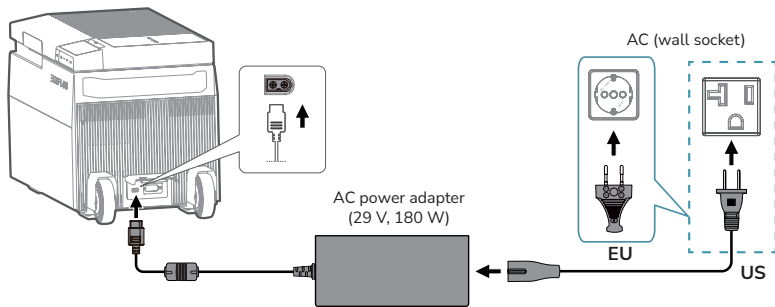

This product supports AC mains.

When connected to the AC mains, short press the power button to turn on the product, and the product will operate normally. At this time, if the EFBX100-EB battery pack (optional) is connected, the product will give priority to the refrigeration power of the refrigerator through the built-in intelligent charging algorithm, and charge the battery pack at the optimal power.

Car charging

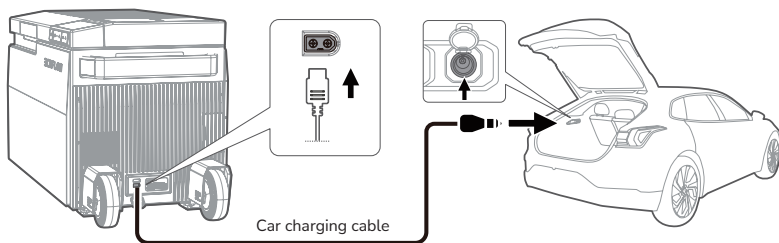

This product supports car charging through the 12 V/24 V car charging port and charges the connected EFBX100-EB battery pack (optional) with a maximum current of 8 A.

**NOTICE!**

When this product is connected to the 12 V car charging port for power, keep the EFBX100-EB battery pack (optional) connected. Otherwise, the ice making function cannot be used normally.

When this product is connected to the 24 V car charging port for power, you can disconnect the EFBX100-EB battery pack. This does not affect the functioning of the product.



When the firmware of this product is upgraded, please keep the power supply stable. If you have an EFBX100-EB battery pack, please connect it to this product to upgrade the firmware at the same time and make sure its SOC (State Of Charge) is more than 5%.

Using the battery protection



This device is equipped with 3-stage battery protection, which can be turned on/off through EcoFlow APP. The battery protection prevents excessive discharging when the device is connected to a vehicle starter battery (lead-acid battery).

When not connected to EFBX100-EB battery pack (optional), the device switches off automatically as soon as the supply voltage falls below a set level. The device will switch back on once the battery has been recharged to the restart voltage level.

When connected to EFBX100-EB battery pack (optional) and the power supply voltage falls below the set value, the device will automatically switch to EFBX100-EB battery pack power supply and will not automatically shut down.



NOTICE! When connecting to portable power station for power supply, please turn off the battery protection function.

		Low	Medium	High	
12V		Power off	8.5V	10.1V	11.1V
		Power on	10.9V	11.4V	12.4V
24V		Power off	21.3V	22.3V	24.3V
		Power on	22.7V	23.7V	25.7V

Solar charging

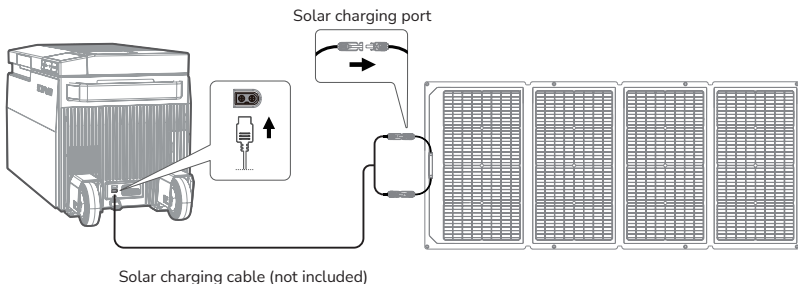
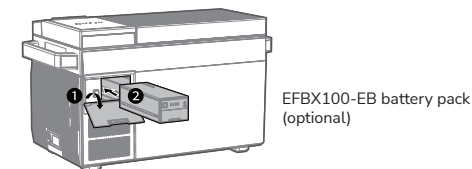

This product supports solar charging and supports charging the EFBX100-EB battery pack (optional) with a maximum power of 180 W.

NOTICE! When the device is connected to the solar charger, keep the EFBX100-EB battery pack (optional) connected. Otherwise, the device cannot work properly.

How to Use the Product

Refrigerator parts and food storage suggestions

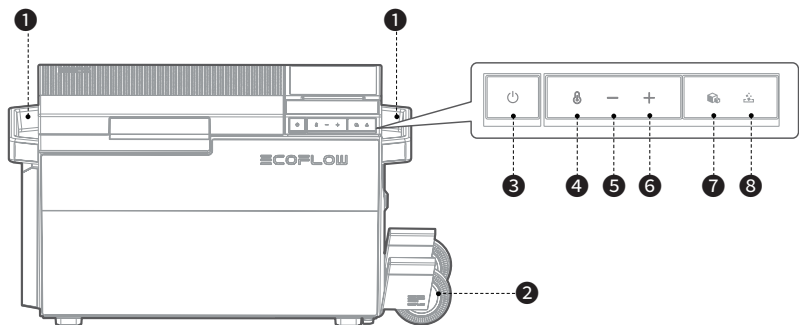

1. Detachable handle
2. Detachable wheels (optional)
3. Power button
4. Temperature zone switching button
5. Temperature increase/Next button
6. Temperature decrease/Previous button
7. Ice making button
8. Ice detaching button (You can press the button to cancel ice-making operation or manually detach ice from bullet-head-shaped component of the ice maker for access to ice cubes.)

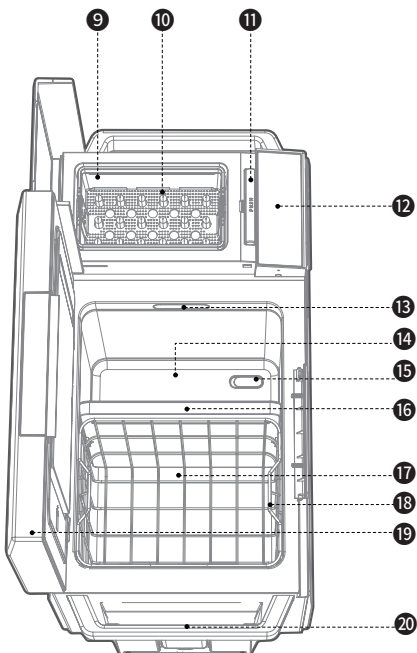

9. Ice basket
10. Ice making compartment
11. Ice making compartment button
12. LCD
13. Light
14. Right zone
15. Drain plug
16. Temperature zone divider (removable to store oversized food)
17. Left zone
18. Basket
19. Refrigerator door
20. Detachable Telescopic Handle (optional)

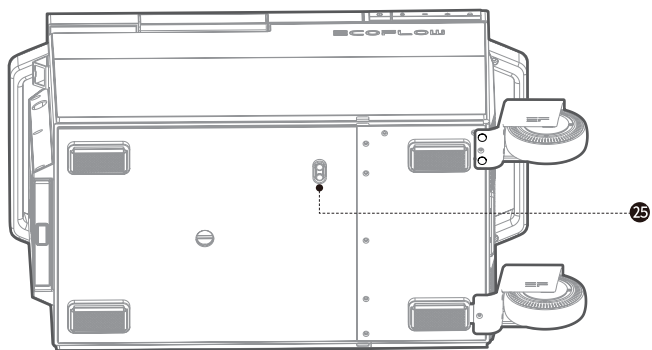
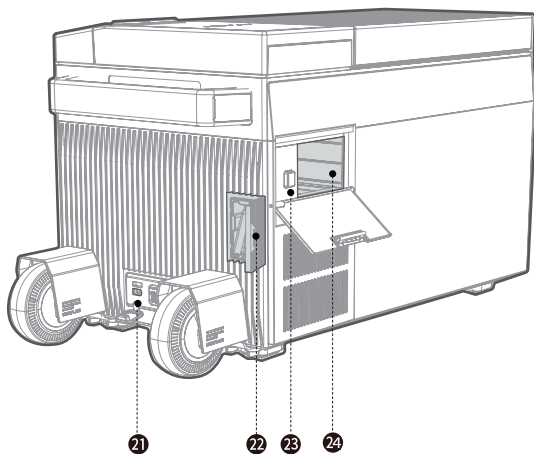

- 21. Power connector
- 22. Ice maker drain pipe
- 23. Battery removal button
- 24. Battery compartment
- 25. Drainage hole

LCD indicators

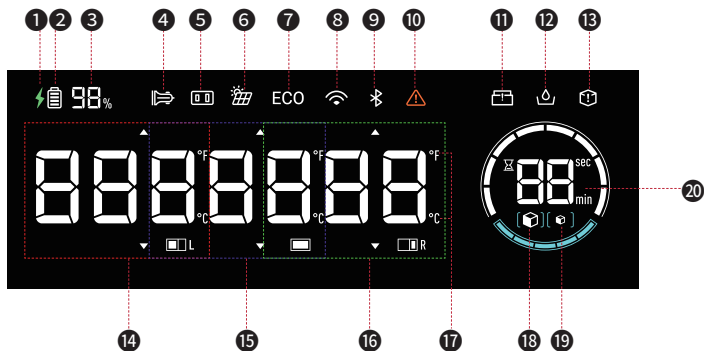

- | | |
|--|--|
| 1. Charging | 12. Ice-making water shortage |
| 2. Battery level estimator | 13. Cannot make ice indicator |
| 3. Remaining battery percentage | 14. Left zone temperature |
| 4. Car charging connection | 15. Single zone temperature (after removing the zone divider) |
| 5. Adapter connection | 16. Right zone temperature |
| 6. Solar input | 17. Temperature units (switchable by long pressing "0" or via App) |
| 7. ECO mode (switchable by long pressing "-" or via App) | 18. Large ice cubes |
| 8. Wi-Fi connection | 19. Small ice cubes |
| 9. Bluetooth connection | 20. Ice making / manually ice detaching time |
| 10. Failure warning | 21. Error code (see Error Display and Troubleshooting) |
| 11. Basket missing | |

Power-On/Off

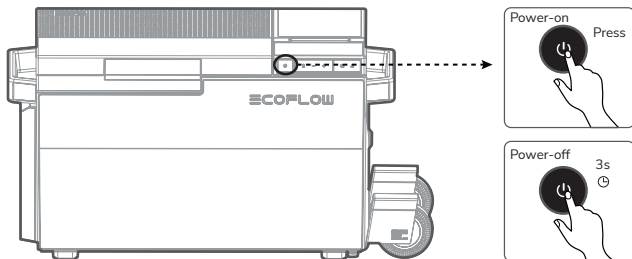

Power-on: Press the power button to turn on the device. The general power indicator becomes fixed.

When you do not operate the device for 5 minutes (default, configurable in the app), the LCD will automatically turn off. When you operate the product, the LCD will be automatically lit. To manually turn off the LCD, press the power button. To manually turn on the LCD, press any button.

Power-off: Press and hold the power button for 3s. The LCD displays "OFF" for 3s. Then, the refrigerator is turned off. You can also turn off the refrigerator remotely through the app. When this product is connected to a power source, it can charge the connected EFBX100-EB battery pack regardless of whether it is powered on or not.

Temperature settings and functional operations

Dual zone temperature settings

After powering on the refrigerator, short press the temperature zone switching button to select the desired zone, then the temperature digits blink. Press + or - to adjust the temperature or long press to quickly reach the desired temperature value: $\pm 5^{\circ}\text{C}$; set another zone temperature value in the same way. The setting is completed after there is no operation in 2s. You can also set the temperature remotely through the Ecoflow app.

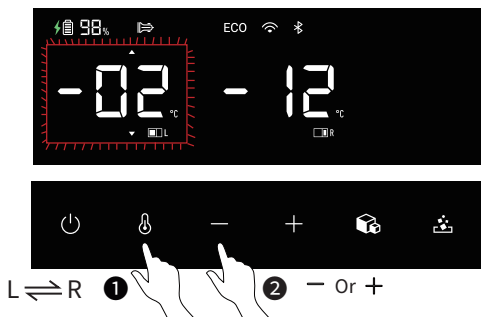

! NOTICE!

1. The left zone is up to 25°C(77°F) higher than the right zone, or the right zone is up to 15°C(59°F) higher than the left zone.
2. It is recommended that the left zone be set as fridge mode and the right zone be set as freezer mode.

Fridge mode	0°C to 10°C (32°F to 50°F)
Freezer mode	-25°C to 0°C (-13°F to 32°F)
Recommended temperatures	Water: 5°C (41°F) Fruit: 5°C to 8°C(41°F to 46°F) Juice: 8°C to 10°C(46°F to 50°F) Red wine: 13°C (55°F) Drinks: 5°C to 7°C (41°F to 45°F) Vegetable: 3°C to 10°C (37°F to 50°F) Meat: -20°C to -18°C(-4°F to 0°F) Seafood: -3°C (27°F) Prepared food: 4°C(39°F) Frozen food: -18°C (0°F)

Single zone temperature setting

After removing the temperature zone divider, short press the temperature zone switching button to enter the single temperature zone setting mode, then the temperature digits blink. Press + or - to adjust the temperature. The setting is completed after there is no operation in 2s. You can also set the temperature remotely through the app.

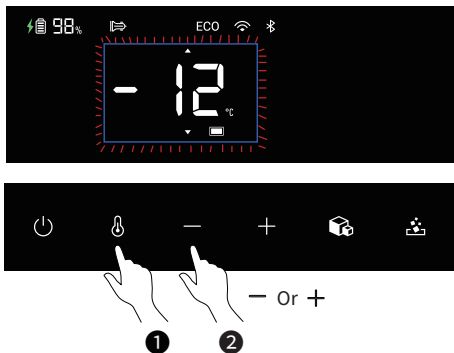
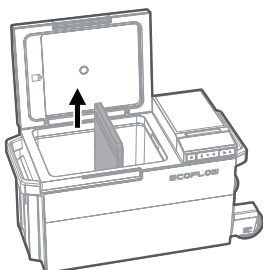

Fridge mode	0°C to 10°C (32°F to 50°F)
Freezer mode	-25°C to 0°C (-13°F to 32°F)
Recommended temperatures	Water: 5°C (41°F) Fruit: 5°C to 8°C(41°F to 46°F) Juice: 8°C to 10°C(46°F to 50°F) Red wine: 13°C (55°F) Drinks: 5°C to 7°C (41°F to 45°F) Vegetable: 3°C to 10°C (37°F to 50°F) Meat: -20°C to -18°C(-4°F to 0°F) Seafood: -3°C (27°F) Prepared food: 4°C(39°F) Frozen food: -18°C (0°F)

After removing the temperature zone divider, it can be attached to the inside of the refrigerator door.

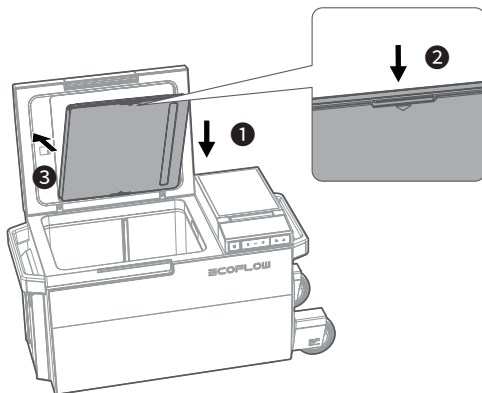

Making Ice Cubes

1. It is recommended to clean the ice maker and ice container every time ice is made. (see **Care and Maintenance** part)
2. Press the **PUSH** button on the ice maker to open the lid, then fill portable water into the ice maker. The water level should not be lower than the minimum scale line (**MIN**) or exceed the maximum scale line (**MAX**). Confirm that the ice container is in place. Otherwise, the LCD will prompt that the ice basket is missing and the ice maker cannot work.
3. Close the lid, then short press the ice making button, and the ice cube icon will flash, finally short press the ice making button again to select large ice/small ice, after 5 seconds with no operation, ice making will start: the ring icon will start to rotate and the screen will show the current time needed for ice making, a single ice making time is 8-20 minutes at room temperature (water temperature <math><30^{\circ}\text{C}</math> (86°F)). Before starting ice making, you can press the ice detaching button to cancel ice making operation, or press it to manually detach ice from bullet-head-shaped component of the ice maker for access to ice cubes after starting ice making.
4. When the ice making is finished, there is a beeping sound and the Ecoflow APP prompts as well, then open the lid, lift one end of the basket and then the other end, now enjoy the ice.



NOTICE!

1. **Fill with potable water only.** It is recommended to use cold water instead of hot water. Otherwise, it will increase power consumption. If the water temperature exceeds 50°C , the ice maker cannot work.
2. It is recommended to clean the ice maker regularly to prevent odor.
3. A single filling of water to the maximum scale line will satisfy approximately 4 ice making sessions.
4. When making ice multiple times in a row, there will be a certain degree of temperature increase in single/dual zones.
5. When connecting to the 12V car charging supply, the refrigerator must be connected to the EFBX100-EB battery pack for ice making.

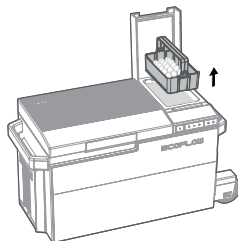
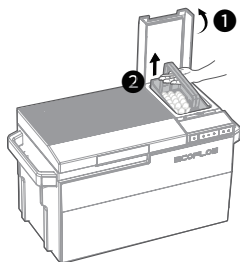
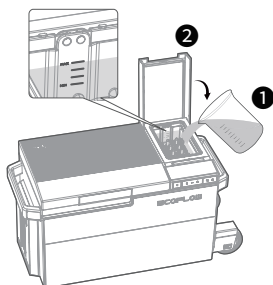
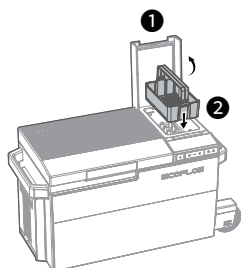

- It is recommended you store the ice cubes in the single/dual zone.
- During the ice making process, you can still select large/small ice cubes by short pressing the ice making button.
- Ice making will increase power consumption. Do not turn on ice making if you do not need it.
- When the ice maker is not in use for a long period, clean and dry the internal components of the ice maker to prevent mildew.
- The ice maker is disabled in factory settings.

Precautions

Fridge mode

1. The fridge mode is used to store food that should not be frozen and have a short storage period. It is suitable for storing fresh food rather than food that is perishable at low temperatures.
2. Hot food should be cooled before putting into the refrigerator. Otherwise, the temperature in the refrigerator will rise, affecting the freshness of other food and increasing the power consumption.
3. Do not open the refrigerator door frequently. Otherwise, the temperature inside the refrigerator will rise. Do not store too much food in the refrigerator. Otherwise, the refrigerator door cannot close.
4. Please use plastic wrap or plastic bag to seal the container or use a covered container to store food, which can avoid the evaporation of food moisture, preserve the flavor and nutrition of food, and reduce the odor inside the refrigerator.

Freezer mode



WARNING!

1. The freezer mode is used to store frozen food with a long storage period. It is suitable for frozen food such as meat, sausage, poultry, and fish.
2. Do not put bottles into the freezer to prevent the contents of the bottles from freezing and causing the bottle body to rupture and cause injuries.
3. Do not put thawed food into the freezer, which may make the food lose the taste and nutrition.
4. Do not directly touch the interior of the freezer or metal containers with wet hands. Otherwise, it may cause frostbite.

Care and Maintenance

How to Remove and Clean Internal Parts



WARNING!

1. Please disconnect all power before cleaning to ensure safety.
2. After cleaning the refrigerator, install the disassembled parts back in reverse order. Do not use excessive force when disassembling the parts to prevent damage.
3. Wipe with a soft cloth dampened with a neutral detergent. Do not use cleaning powder, benzene, hydrochloric acid, hot water, rough brushes, abrasive cleaning agents or hard objects to clean the refrigerator. Otherwise, it will damage or corrode the refrigerator.
4. Regularly clean the inside and outside of the refrigerator with a damp cloth.
5. Never clean the device under running water or immerse it in water.
6. Ensure that the air inlets and outlets on the refrigerator are free of any dust and dirt for good ventilation.

7. After cleaning, please check whether the power cable is damaged or wet, and whether the power plug is overheated. You can plug in the power supply only after confirming that everything is normal.
8. Before plugging in the power supply, please use a soft dry cloth or sponge to dry any moisture to avoid water or other liquids remaining in the electrical components, to avoid electric shock or short circuit.

Drainage

Single/dual zone drainage

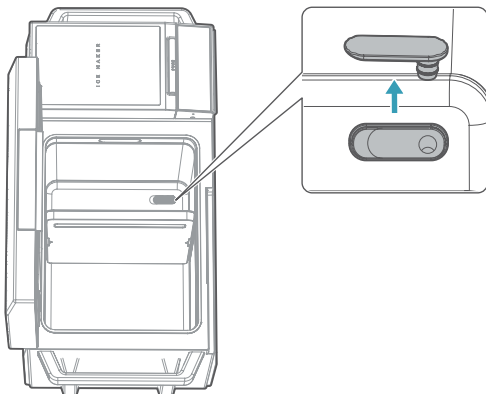

Ice maker drainage

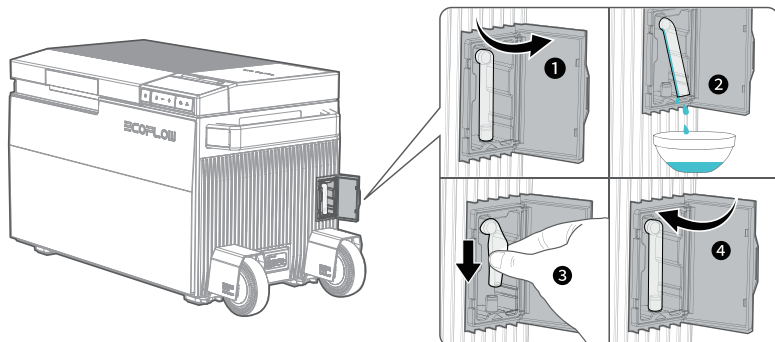

Defrosting

Moisture can form frost inside the refrigerator or on the evaporator. This will reduce refrigeration capacity. Please defrost the refrigerator to avoid such situations.



- NOTICE!**
- Do not use hard or sharp tools to remove ice or loosen frozen items.
 - Do not use mechanical devices or other methods not recommended by the manufacturer to speed up the defrosting process.

1. Take out all items from the refrigerator.
2. Chill them in another refrigerator if necessary.
3. Turn off the refrigerator.
4. Leave the refrigerator door open.
5. Use a clean rag to wipe off any water stains.

Error Display and Troubleshooting

Fault Code	Fault Name	Suggested Solution
1004	Tilt angle is too large	Place the device horizontally.
2004	Input is overvoltage	Replace the input source.
2005	Input is undervoltage	Replace the input source.
3021	Ambient temperature is too high	Please use within the temperature range allowed by the device.
3023	Water temperature is too high	Please use within the temperature range allowed by the device.
4009	Battery pack discharging overtemperature	Please use within the temperature range allowed by the device.
4010	Battery pack discharging undertemperature	Please use within the temperature range allowed by the device.
4011	Battery pack charging overtemperature	Please use within the temperature range allowed by the device.
4012	Battery pack charging undertemperature	Please use within the temperature range allowed by the device.
4020	Battery pack MOS undertemperature	Please use within the temperature range allowed by the device.
Others	-	Unplug the device all power (including the battery pack), re-power, if the issue persists, please contact the after-sales.

Package Contents

EFBX100 × 1

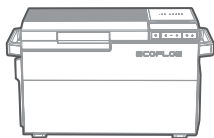

AC power adapter + cable × 1

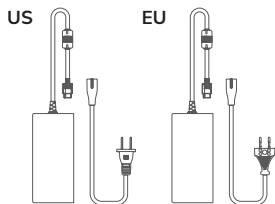

Car charging cable × 1

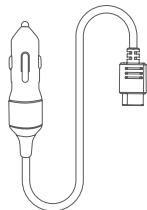

Quick Start Guide × 1
Warranty Card × 1

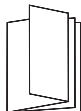

Left zone basket × 1



Ice shovel × 1



≡COFLOW